

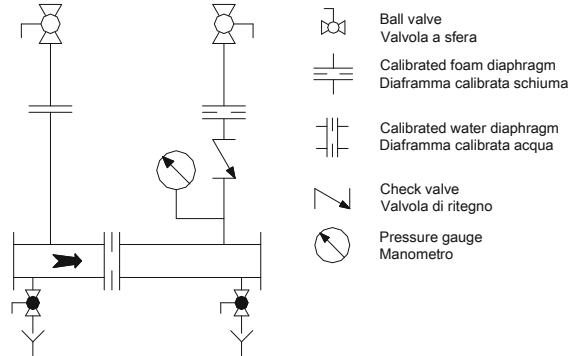

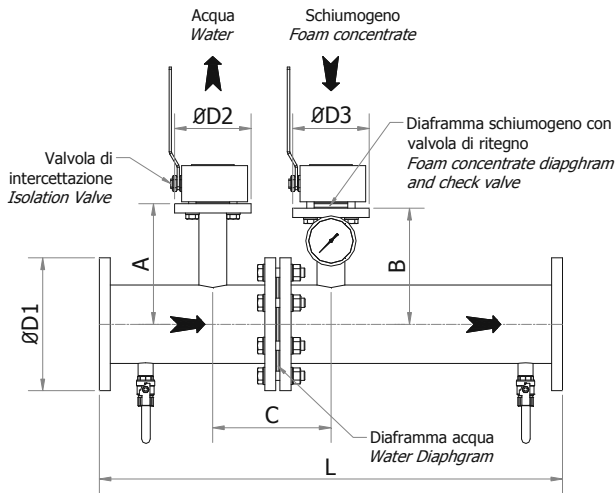



# Miscelatore standard range per serbatoio a membrana Standard Range Mixer for bladder tank



Model

**MIX**



-  Ball valve  
Valvola a sfera
-  Calibrated foam diaphragm  
Diaframma calibrata schiuma
-  Calibrated water diaphragm  
Diaframma calibrata acqua
-  Check valve  
Valvola di ritegno
-  Pressure gauge  
Manometro

Modello Model	ØD1	Portata, l/min Flow rate, l/min		ØD2 ØD3	A	B	C	L	Peso, kg Weight, kg
		min	max						
MIX - 1"	1"	30	200	½"	167	157	100	500	12
MIX - 1½"	1½"	50	300	1"	174	164	200	700	16
MIX - 2"	2"	75	450	1"	180	170	200	700	20
MIX - 2½"	2½"	75	650	1½"	213	203	255	1000	30
MIX - 3"A	3"	100	900	1½"	219	209	255	1000	33
MIX - 3"B		150	1250						
MIX - 4"A	4"	250	1800	1½"	232	222	255	1000	38
MIX - 4"B		380	2700						
MIX - 6"A	6"	450	3500	2"	259	249	255	1000	72
MIX - 6"B		650	5500						
MIX - 8"	8"	1100	8000	2½"	285	275	300	1000	96
MIX - 10"	10"	1680	11000	3"	312	302	300	1000	132
MIX - 12"A	12"	3500	21000	4"	337	327	320	1000	160
MIX - 12"B		4000	24000						
MIX - 14"	14"	5000	30000	4"	353	343	380	1000	190
MIX - 16"	16"	6000	36000	4"	378	368	380	1000	230

## Specifiche – Specifications

Flange*: ISO PN16 o ANSI # 150 – A105 acciaio al carbonio,	Flanges*: ISO PN16 o ANSI #150 – A105 Carbon Steel
Tubi*: acciaio al carbonio ASTM A106 Gr.B	Pipes*: carbon steel ASTM A106 Gr.B
Diaframma acqua/schiuma: acciaio inox AISI 316	Water/Foam conc. diaphragm: stainless steel AISI 316
Manometri: acciaio inox	Pressure gauges: stainless steel
Valvole di drenaggio: corpo in ottone nichelato, sfera in acciaio inox 316	Drainage Valves: body: nickel plated brass with AISI 316 stainless steel ball
Valvole di intercettazione acqua/schiumogeno: corpo: ASTM A 105 acciaio al carbonio* sfera: acciaio inox AISI 316	Water and foam concentrate intersection valves: Body: ASTM A 105 carbon steel*, with AISI 316 stainless steel ball
Guarnizioni: senza amianto	Gaskets: asbestos free
Rapporto di miscela: 1%, 3%, 6% (preselezionato)	Mixing ratio: 1%, 3%, 6% (pre-selected)
*Opzione: acciaio inox AISI 316 o AISI 304	*Option: stainless steel AISI 316 or AISI 304

## Certificazioni - Certifications



**C.S.I. s.r.l.**

Rev. 15.1

# Miscelatore standard range per serbatoio a membrana *Standard Range Mixer for bladder tank*

Model

**MIX**



**Diagramma perdita di carico – Pressure loss diagram**

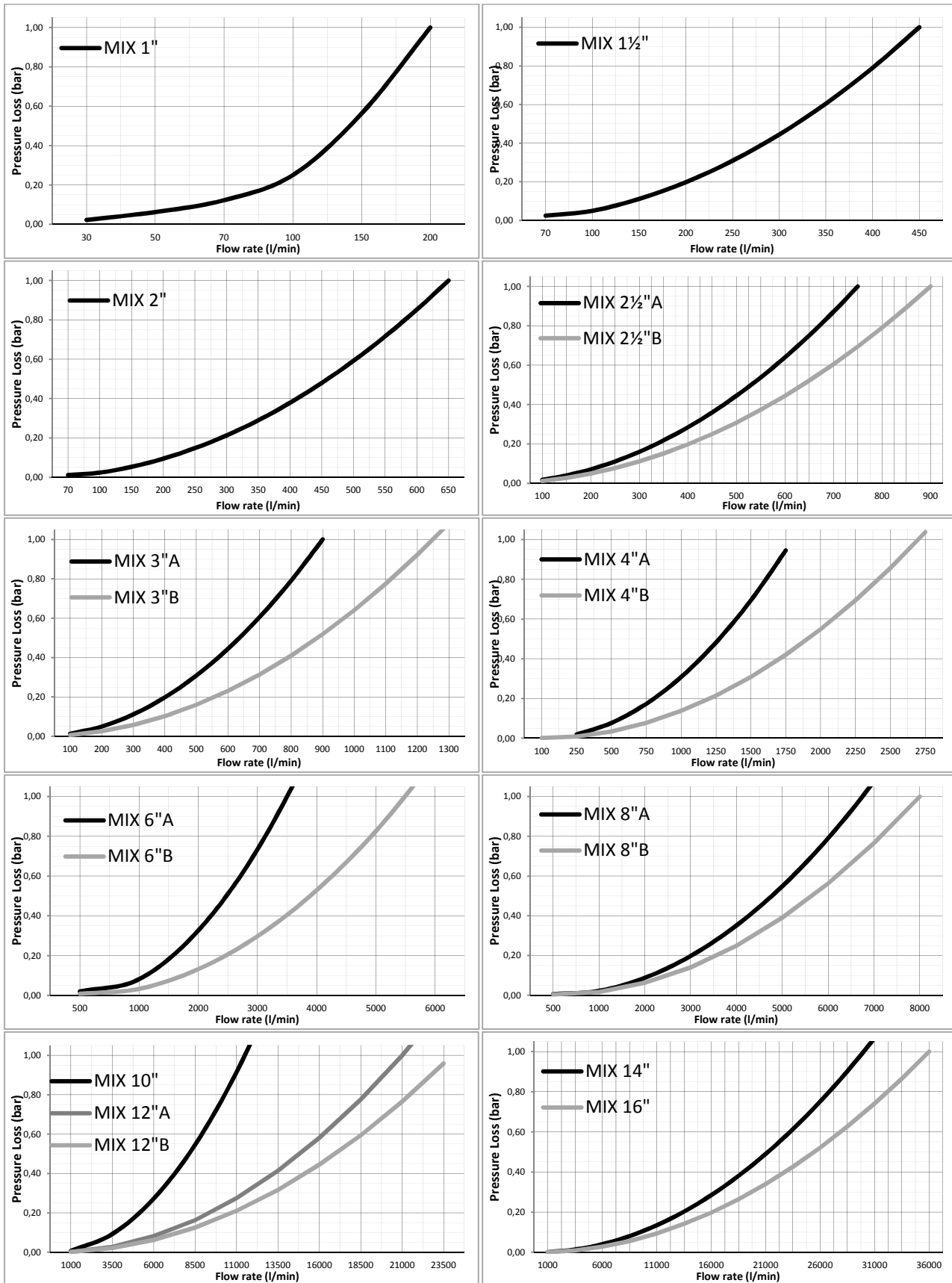

**C.S.I. s.r.l.**

Rev. 15.1